

Level 2 PowerPost® EVSE Wall Mount Unit Installation & User Manual

This page was left Blank Intentionally

Contents

IMPORTANT SAFETY INSTRUCTIONS – PLEASE READ	1
INSTALLATION	2
Tools & Materials Required for Installation.....	2
Electrical Requirements.....	3
Mechanical Requirements.....	3
Installation Procedure.....	4
OPERATION	7
Status Indicator Lights.....	8
Initial Power-Up	8
Cable Extension & Vehicle Connection.....	8
Vehicle Disconnection & Cable Retraction	9
TROUBLESHOOTING	10
CLEANING	12
SERVICE / REPAIR	12
Removing Electronics Module Cover.....	13
Input Power Fuse Replacement	13
Electronics Module Replacement.....	14
Cord Reel & Cable Assembly Replacement.....	15
LIMITED WARRANTY AND EXCLUSIONS	16
COMPLIANCE	17
SPECIFICATIONS	17
Mechanical	17
Electrical.....	17
OTHER	17
PATENTS	17
SOFTWARE	17
CONTACT INFORMATION	19

Symbols and Important Safety Messages Used on this Manual:



This symbol precedes a Warning, a Caution or Important message.



This symbol means there is a risk of electric shock and precedes a Warning, Caution or statement related to wiring.



WARNING Indicates a potentially hazardous situation that can result in serious injury or death if it is not avoided.



CAUTION Indicates a situation that can damage equipment and possibly result in injury.



IMPORTANT Indicates critical information pertaining to: local codes, installation or operation of the equipment.

IMPORTANT SAFETY INSTRUCTIONS – PLEASE READ SAVE THESE INSTRUCTIONS



WARNING – When using electric products, basic precautions should always be followed including the following:

- Read all the instructions before using the L2 PowerPost® EVSE by Konnectronix.
- This device should be supervised when used around children.
- Do not put fingers into charge coupler or vehicle connector.
- Do not use the L2 PowerPost® EVSE if the flexible power cord or EV cable are frayed, have broken insulation, or any other signs of damage.
- Do not use the L2 PowerPost® EVSE if the enclosure or the charge coupler is broken, cracked, open or shows any other indication of damage.
- Charge coupler is not intended for current interrupting.
- Do not operate the L2 PowerPost® EVSE in temperatures below -22°F (-30°C) or above 122°F (50°C).
- Do not install the L2 PowerPost® EVSE in close proximity to combustible materials or flammable vapors.



WARNING; CORD REEL ASSEMBLY – Do not disassemble the cord reel assembly in the L2 PowerPost® EVSE. Failure to heed this warning can result in serious injury or death. Due to the high-tension power spring inside the assembly, the cord reel should only be serviced by Konnectronix Inc.



GROUNDING INSTRUCTIONS – This product must be connected to a grounded, metal, permanent wiring system; or an equipment-grounding conductor must be run with the circuit conductors and connected to the equipment grounding terminal or lead on the product.



CAUTION – The L2 PowerPost® EVSE is intended for use with vehicles conforming to Society of Automotive Engineers (SAE) standard J1772. Using it for any other applications can damage the L2 PowerPost® EVSE and/or the nonconforming vehicle

INSTALLATION



IMPORTANT:

- / Check with state and local authorities to ensure compliance with codes and ordinances before starting installation.
- / The L2 PowerPost® EVSE must be installed by a licensed electrician.
- / This device shall be mounted to a concrete or filled cmu wall so that the height of the storage means for the coupling device is located between 450 mm (18 inches) and 1.2 m (4 feet) from grade.



WARNING:

- / The L2 PowerPost® EVSE must be connected to a grounded, metal, permanent wiring system; or an equipment-grounding conductor must be run with the circuit conductors and connected to the equipment grounding terminal or lead on the product.
- / To reduce the risk of fire, connect only to a circuit provided with 20 amperes maximum branch circuit over-current protection in accordance with the National Electrical Code, ANSI/NFPA 70.
- / Always interrupt the power supply to the L2 PowerPost® EVSE before opening the case.
- / Never insert anything (fingers, tools, etc.) into the L2 PowerPost® EVSE charge coupler.
- / The L2 PowerPost® EVSE is designed for use with plug-in vehicles equipped with vehicle connectors that meet SAE standard J1772. Use of the product for any other application can damage the L2 PowerPost® EVSE and / or the vehicle.
- / Do not use the L2 PowerPost® EVSE if the cable is frayed or the insulation is damaged.
- / Do not use the L2 PowerPost® EVSE if the case has been severely damaged.

Tools & Materials Required for Installation

- / Security Hex Bit (supplied with unit)
- / #2 Flat Head Screwdriver
- / Bubble Level or equivalent
- / Wire stripper 10-12 AWG
- / Torque wrench with 3/8" socket
- / Concrete anchors P/N Hilti KB3 3/8" x 3-3/4" LT SS304 (supplied with unit)
- / Conduit attachment flange
- / 3/8" Concrete Drill Bit

Electrical Requirements

- / Circuit Protection: Dedicated 208-240V 50/60Hz 20A circuit
- / Conduit/Cable Penetration: Electrical supply cable enters from the bottom of the unit.
- / Supply wire size: 12 AWG min (75°C Copper wire).
- / Free cable length: 52 inch Min length beyond end of conduit

Mechanical requirements

- / Four concrete anchors with tensile strength of 450 lbs or more. (See Figure 1 for spacing)
- / Concrete or filled cmu wall that can support pressure loads of 2000 PSI or more.

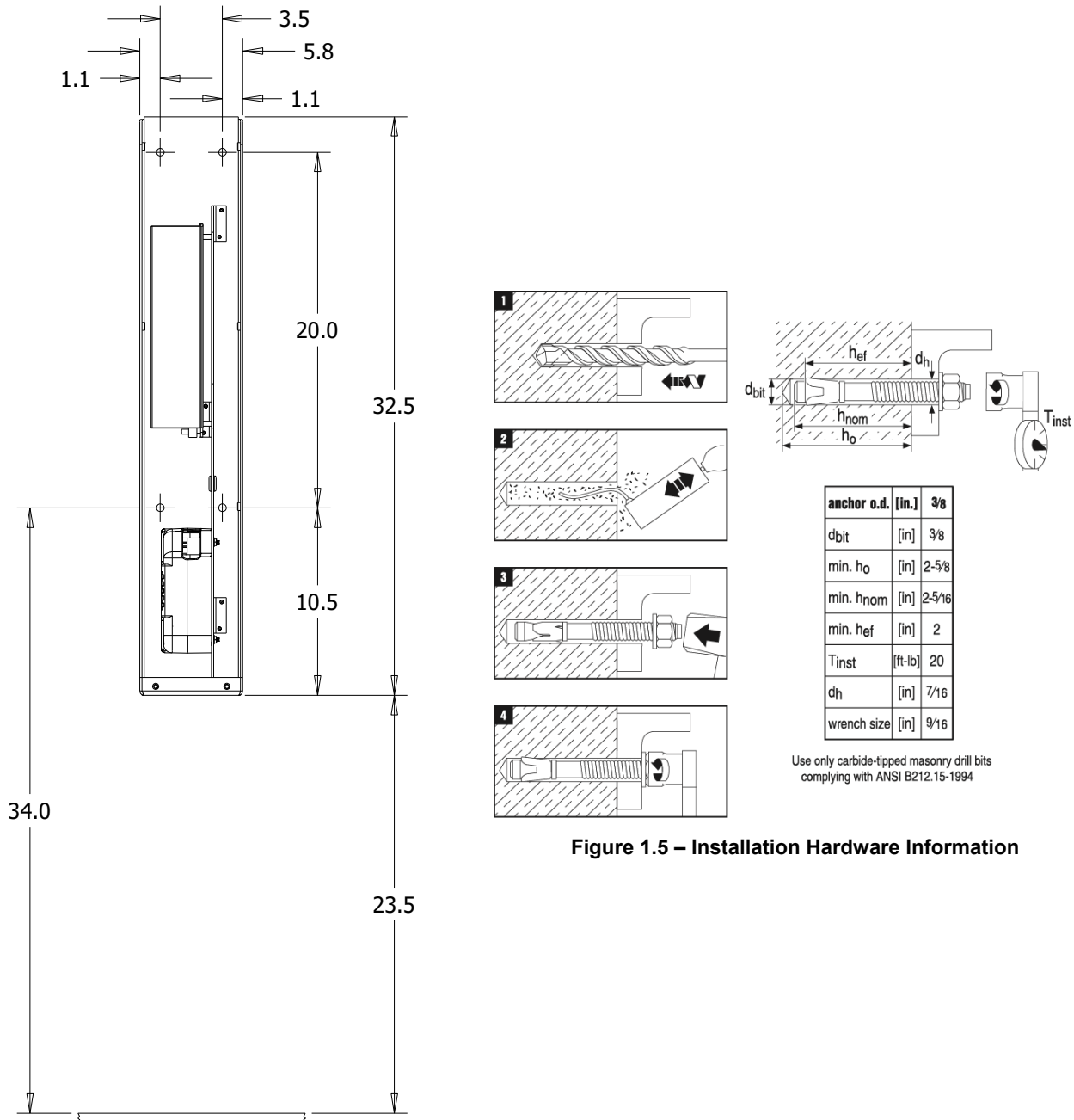

Figure 1.5 – Installation Hardware Information

Figure 1 – L2 PowerPost® EVSE Mounting Hole Locations

Installation Procedure

1. Ensure supply power to the charging station is interrupted and properly locked out.
2. Remove L2 PowerPost® EVSE from packaging.
3. Pull charge coupler and cable out completely (approximately 14 feet) until last ratchet stop of cord reel. (See Figure 2)



WARNING: Pulling charging cable out of the L2 PowerPost® EVSE with excessive force when station is not stable can result in damage to the unit or injury.

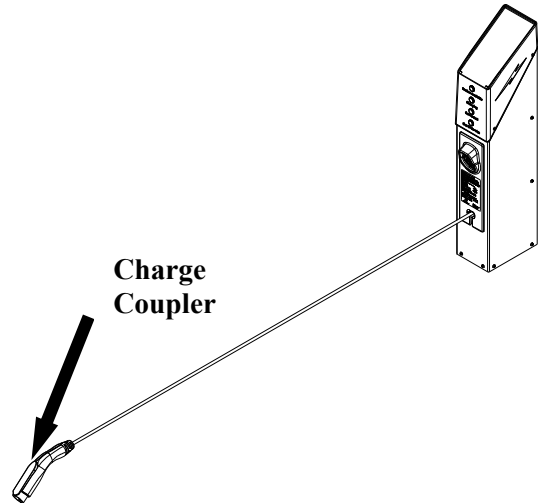

Figure 2 - Charge cable extended

4. Remove 4 screws that attach the top cover to the charging base (use security hex bit provided). Retain screws separately for later installation. Gently lift the top cover ~6 inches. (See Figure 3) Disconnect LED cable harness connector from charging base harness by pressing release tab and pulling gently apart. (See Figure 4)

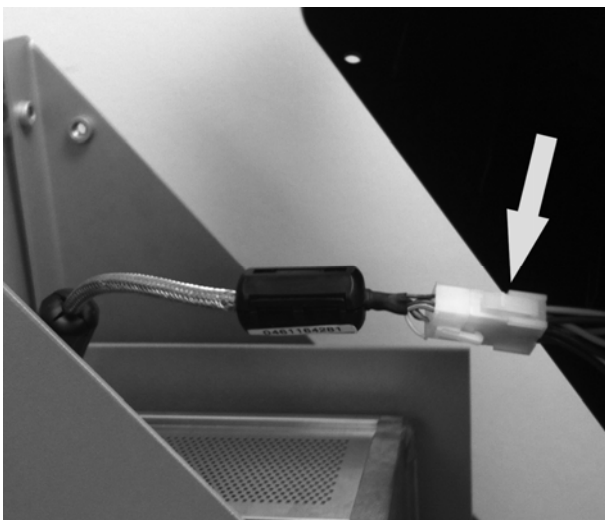

Figure 4 - LED cable harness connector

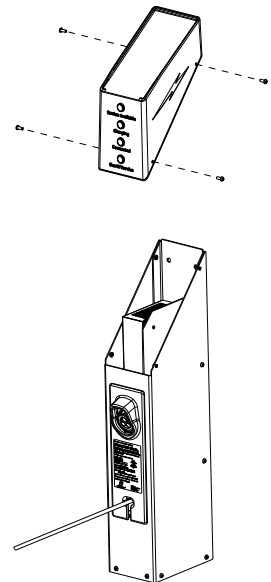

Figure 3 – Top Cover Removed

Installation Procedure (continued)

5. Remove 6 screws in the lower front and sides of the unit that attach the front housing to the charging base. Remove 4 screws on the side of the unit that attach the front housing to the charging base. Retain screws for later installation. Gently lift the front housing ~ 2" inch and slide forward and out of the way. (See Figure 5)
6. Mark hole locations (see Page 3) on concrete wall that the L2 PowerPost® EVSE will be mounted to. Drill (4) 2-7/8" deep holes in locations provided using 3/8" masonry drill bit.
7. Install concrete anchors in pre-drilled holes (2-1/2" Embedment). Hang charging station on concrete anchors. Shim as necessary to plumb unit. Torque down anchors to 20 ft-lb.

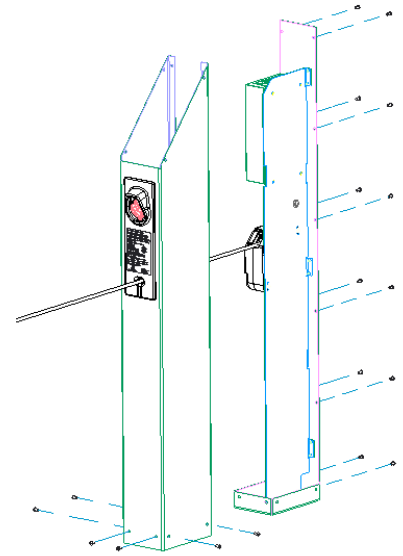

Figure 5 – Front Housing Removed



IMPORTANT: Torque fasteners to 20 ft-lb. (See Figure 6)

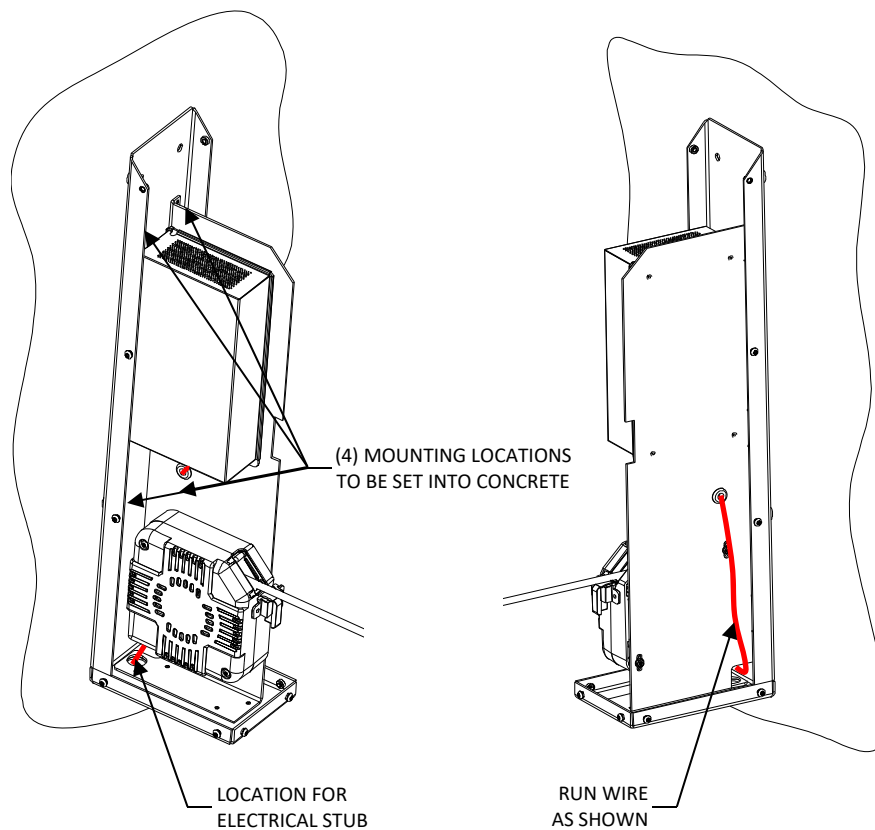



Figure 6 – Input Wiring Routing

Installation Procedure (continued)

8. Feed electrical supply through bottom entry location in middle of unit. Feed wires to right of unit through bottom rear wire access hole. Route cable upwards and feed from right to left of unit through cable pass-through grommet between cord reel and circuit board. (See Figure 6 on previous page and Figure 7 below)

9. Terminate Line1, Line2, and Ground wires per Figure 7.

 **IMPORTANT:** Torque line termination screws to 20 inch-pounds.

10. Install the 6 screws in the lower front and sides of the unit that attach the front housing to the charging base. (See Figure 6 on previous page)

 **IMPORTANT:** Torque screws to 15 – 20 in-lbs

11. Carefully position front housing on charging base. Install the 4 screws in the back of the unit that attach the front housing to the charging base.

 **IMPORTANT:** Torque screws to 15 – 20 in-lbs

12. Re-connect LED cable harness connector to charging base harness. Gently place the top cover on the charging base, making sure not to pinch the LED cable harness. Install the 4 screws that attach the top cover to the charging base.

 **IMPORTANT:** Use hand tools on step 12 to avoid cracking of unit. Torque screws to 15 - 20 in-lbs.

13. Return the charging cable to the cord reel by pulling cable approximate ½ inch to allow cable to retract into L2 PowerPost® EVSE. Place charging coupler into connector storage receptacle. (See Figure 8)

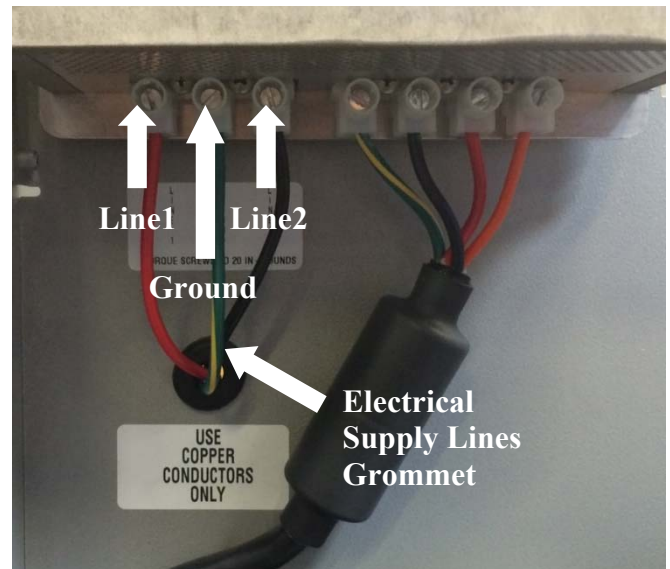

Figure 7 – Input Wiring Termination

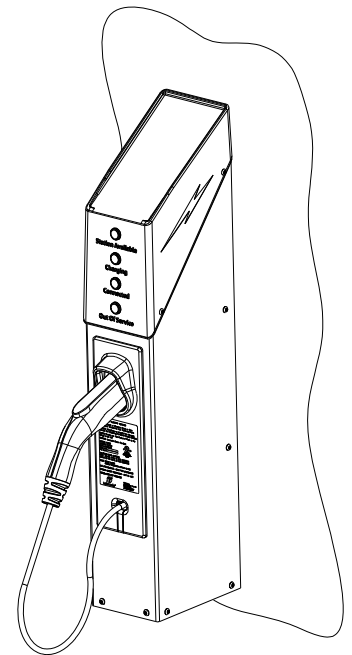

Figure 8 – Completed Installation

Installation Procedure (continued)

14. Restore supply power to the L2 PowerPost® EVSE. This will initiate a self-test and the status lights may flash. The green “Station Available” indicator light will remain illuminated. (See Figure 9) If red “Out Of Service” indicator stays illuminated, refer to Troubleshooting section. (See Figure 10)



Figure 9 - Station Available



Figure 10 – Out of Service

OPERATION

WARNING

- ✓ The L2 PowerPost® EVSE is designed for use with plug-in vehicles equipped with vehicle connectors that meet SAE standard J1772. Use of the product for any other application can damage the L2 PowerPost® EVSE and / or the vehicle.
- ✓ Never insert anything (fingers, tools, etc.) into the L2 PowerPost® EVSE charge coupler.
- ✓ Always retract charging cable (pull cable to stow) when the L2 PowerPost® EVSE is not in use to reduce cable damage and tripping hazards. Do not leave connector lying on the ground.
- ✓ Do not use the L2 PowerPost® EVSE in close proximity to combustible materials or in the presence of flammable vapors.
- ✓ Do not use the L2 PowerPost® EVSE if the cable is frayed or the insulation is damaged
- ✓ Do not use the L2 PowerPost® EVSE if the case has been visibly damaged, crushed, or is not properly secured to the mounting base.

OPERATION (continued)

Status Indicator Lights

- Station Available (Green)

Indicates the L2 PowerPost® EVSE has power and is ready to charge a vehicle.

- Charging (Blue)

Indicates a vehicle is currently connected and is being charged by the L2 PowerPost® EVSE.

- Connected (Solid Amber)

Indicates a vehicle is connected but not charging at this time. This typically occurs because the vehicle is fully charged.

- Connected - Awaiting Charging Signal (Blinking Amber)

Indicates a vehicle is connected and requires charging but the vehicle has not yet signaled that it is ready to begin charging. This usually occurs when the vehicle electronics are cooling and have not reached the temperature required for charging.

- Out of Service (Red)

Indicates a problem with the L2 PowerPost® EVSE or the connected plug-in vehicle. Refer to the Troubleshooting section for diagnosis.

Initial Power-Up

- ✓ When supply power is applied to the L2 PowerPost®, it will perform a brief self-test. During this test, the status lights may flash, including the “Out of Service” light. This is normal. Within a few seconds, the green “Station Available” light will illuminate. If there is a problem, the Red “Out of Service” light will illuminate.

Cable Extension & Vehicle Connection

- ✓ Grasp stowed charge coupler and press handle release button with thumb. Gently and smoothly pull coupler and cable out of charging station base. When desired length is reached, allow cable to rewind slightly to nearest ratchet stop. The cable ratchet will engage at approximately 8 inch intervals.



CAUTION: Do not attempt to over-extend cable beyond 14 feet. Damage to the unit may result. Vehicle charging port must be within approximately 10 – 12 feet of charging station to reach safely.

- ✓ Gently plug the charge coupler into the vehicle connector until the latch “Clicks” and locks the two pieces together. The charge coupler must be fully seated in the vehicle connector.

Cable Extension & Vehicle Connection (continued)

- The L2 PowerPost® EVSE will automatically determine the status of the vehicle and begin charging. The blue “Charging” light will illuminate.
 - ✓ If the vehicle does not demand charging power, the amber “Connected” light will illuminate.
 - ✓ If the vehicle requires charging but is not yet ready to accept current, the amber “Connected” light will flash. Charging will begin automatically when the vehicle signals that it is ready and the blue “Charging” light will illuminate.
 - ✓ If the L2 PowerPost® EVSE detects a ground fault condition upon connection to the vehicle, the red “Out of Service” light will illuminate and charging power will be interrupted until the plug is removed. The unit will re-enable charging after a 2-minute interval.
 - ✓ If the L2 PowerPost® EVSE detects a ground fault condition in the middle of charging, the red “Out of Service” light will illuminate and charging power will be interrupted. The unit will re-attempt charging after a 10-second interval.

Vehicle Disconnection & Cable Retraction

- ✓ Grasp charge coupler and press handle release button with thumb. Gently and smoothly pull charge coupler out of vehicle connector.
- ✓ To retract charging cable, pull cable straight out of charging station approximately half an inch to release retraction ratchet. Then allow cable to retract into charging station base.



CAUTION: Do not allow cable to retract in a rapid uncontrolled manner.

- ✓ When cable is fully retracted, insert charge coupler into storage port on charging base.

TROUBLESHOOTING

<u>Problem</u>	<u>Corrective Action</u>
<p>None of the status lights are illuminated. L2 PowerPost® EVSE does NOT charge vehicle when charge coupler is plugged in.</p>	<ul style="list-style-type: none"> • Interrupt power to the L2 PowerPost® EVSE and lock out as appropriate. Disassemble unit per steps 3-5 above. Restore supply power to L2 PowerPost® EVSE. Verify that proper supply voltage is present at the L2 PowerPost® EVSE terminal block. (See Figure 7) • Interrupt power to the L2 PowerPost® EVSE and lock out as appropriate. Verify that supply power wiring is securely terminated to incoming power terminal block. • Interrupt power to the L2 PowerPost® EVSE and lock out as appropriate. Remove incoming power fuse and verify continuity. Replace fuse if blown. • If these steps do not resolve the problem, contact Konnectronix technical support.
<p>None of the status lights are illuminated. L2 PowerPost® EVSE does begin charging vehicle when charge coupler is plugged in.</p>	<ul style="list-style-type: none"> • Interrupt power to the L2 PowerPost® EVSE and lock out as appropriate. Disassemble unit per steps 3-5 in the Installation section. Verify that LED cable harness connector is securely mated to charging base harness. • If these steps do not resolve the problem, contact Konnectronix technical support.
<p>“Station Available” light illuminated, but L2 PowerPost® EVSE does not begin charging vehicle when charge coupler is plugged in.</p>	<ul style="list-style-type: none"> • Interrupt power to the L2 PowerPost® EVSE and lock out as appropriate. Disassemble unit per steps 3-5 in the Installation section. Verify that output power wiring is securely terminated to cord reel terminal block. • If possible, plug the L2 PowerPost® EVSE into a different vehicle • If these steps do not resolve the problem, contact technical support.

TROUBLESHOOTING (continued)

<u>Problem</u>	<u>Corrective Action</u>
<p>“Connected” light illuminates or flashes as soon as vehicle is connected.</p>	<ul style="list-style-type: none">• This occurs when a successful connection to the vehicle is made, but the vehicle is not demanding charging current.• Verify that vehicle batteries are not already fully charged.• Verify that vehicle is set for immediate charging, and is not set for delayed or timer charging.• Verify that vehicle electronics are not being cooled. If cooling system is running, wait until cooling stops. When cooling is complete, the vehicle should automatically signal for charging and the blue “Charging” light will illuminate.• If these steps do not resolve the problem, contact Konnectronix technical support.
<p>“Out of Service” light is illuminated before vehicle is connected.</p>	<ul style="list-style-type: none">• Wait 2 minutes to see if the L2 PowerPost® EVSE returns to normal “Station Available” indication. It may be in a “ground fault timeout” from previous use.• Remove power to the L2 PowerPost® EVSE for at least 30 seconds. Restore power to the L2 PowerPost® EVSE.• If these steps do not resolve the problem, contact Konnectronix technical support.

TROUBLESHOOTING (continued)

<u>Problem</u>	<u>Corrective Action</u>
"Out of Service" light illuminates when vehicle is connected	<ul style="list-style-type: none">• If "Out of Service" light does not extinguish after 1 minute, verify that the L2 PowerPost® EVSE is properly grounded.• Remove charging connector from vehicle. If "Out of Service" light extinguishes, the vehicle batteries may be overheated. Allow vehicle batteries to cool and try charging again.• If "Out of Service" light does not extinguish, the L2 PowerPost® EVSE has detected a ground fault with the vehicle. Wait 2 minutes for the GFI circuit to reset, and then try charging again. If the L2 PowerPost® EVSE trips again, have the vehicle checked. <p>If these steps do not resolve the problem, contact Konnectronix technical support.</p>

CLEANING

- ✓ Always interrupt power supply to the L2 PowerPost® EVSE before cleaning.
- ✓ Clean the L2 PowerPost® EVSE with a damp cloth and mild detergent.
- ✓ Do not use high-pressure water to clean the L2 PowerPost® EVSE.
- ✓ Do not use solvents that may damage the finish or plastics of the L2 PowerPost® EVSE.

SERVICE / REPAIR

Other than periodic cleaning, the L2 PowerPost® EVSE does not require any maintenance.

The input power fuse can be replaced in the field if necessary. The electronics module assembly and the cord reel/cable assembly are each Line Replaceable Units (LRU) that can be removed and replaced in the field. These two assemblies can only be field replaced with a certified LRU assembly only available directly from Konnectronix or authorized distributors.

For any other damage or failures, contact Konnectronix Technical Support.

SERVICE / REPAIR (continued)

Removing Electronics Module Cover

1. Remove the two (2) black ferrite beads on the braided LED cable by opening plastic clamp in center of the bead (see Figure 11 and Figure 12 below).



Figure 11

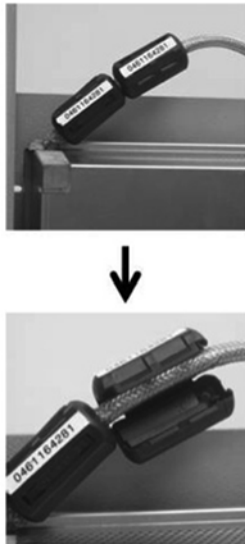

Figure 12



Figure 13

2. Remove metallic tape on bottom of the cover (see Figure 13 above). The tape on top of the cover can be left in place.
3. Remove the bottom cover piece and slide cover up and off of the Electronics Module.

Input Power Fuse Replacement

4. Interrupt power to the L2 PowerPost® EVSE and lock out as appropriate.
5. Disassemble unit per steps 3-5 in the Installation section.



6. Remove Electronics Module cover – see instructions above)
7. Remove and replace fuses with Littlefuse P/N 0N1LN020.T. (See Figure 14).

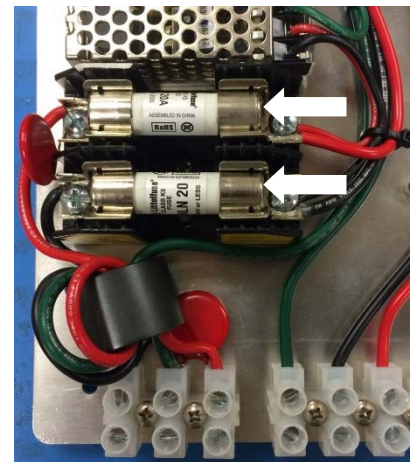

Figure 14 – Power Fuse

WARNING: DO NOT USE ANY OTHER FUSE RATING!!

Damage to the L2 PowerPost® EVSE or serious injury could result.

Electronics Module Replacement

1. Interrupt power to the L2 PowerPost® EVSE and lock out as appropriate
2. Disassemble the L2 PowerPost® EVSE per steps 3-5 in the Installation section.
3. Remove Electronics Module cover – see instructions on page 13)
4. Disconnect the supply wiring and cord reel wiring from their respective terminal blocks. (See Figure 7 in the Installation section)
5. Remove the 4 Philips-head screws holding the Electronics Module in place and remove the module from the chassis. Retain the screws for later re-installation.
6. Install the new Electronics Module using the 4 Phillips-head screws. Torque screws to 8 in-lbs.
7. Reconnect the cord reel wiring to the terminal block per Figure 15.

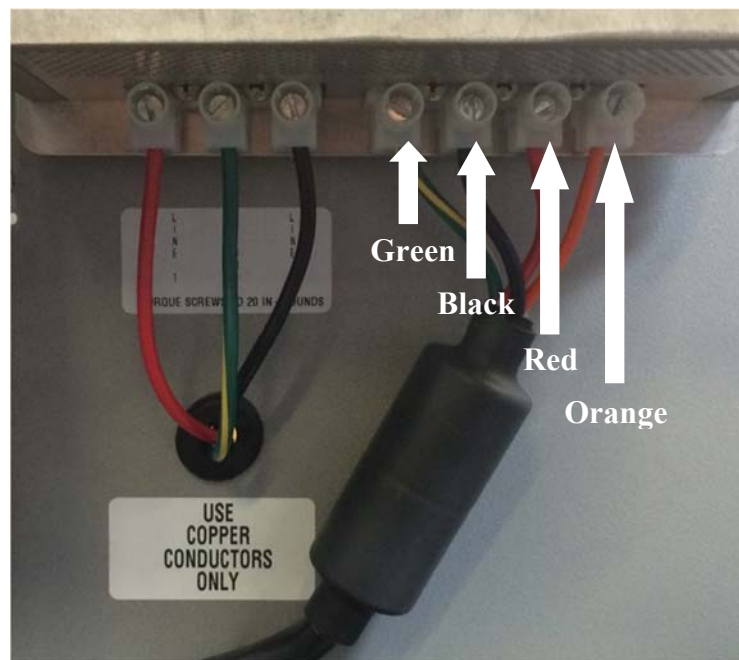

Figure 15 – Cord Reel Wiring Termination

8. Reconnect the supply wiring to the terminal block per Figure 7 in the Installation section.
9. Reinstall Electronics Module Cover using the Removing Electronics Module Cover steps found on page 13 in reverse.
10. Reassemble the L2 PowerPost® EVSE per steps 10-14 in the Installation section.

Cord Reel & Cable Assembly Replacement

WARNING: DO NOT DISASSEMBLE THE CORD REEL

The high tension power-springs inside the cord reel assembly can cause serious injury or death. **The L2 PowerPost® EVSE cord reel assembly should only be serviced by Konnectronix Inc. at a certified Konnectronix facility.**

1. Interrupt power to the L2 PowerPost® EVSE and lock out as appropriate.
2. Disassemble the L2 PowerPost® EVSE per steps 3-5 in the Installation section.
3. Remove the 8 Phillips-head screws from the metal retaining flange attaching the front bezel to the front housing (see Figure 16). Retain the screws for later re-installation. Remove the retaining flange and pull the plastic bezel forward off the housing.

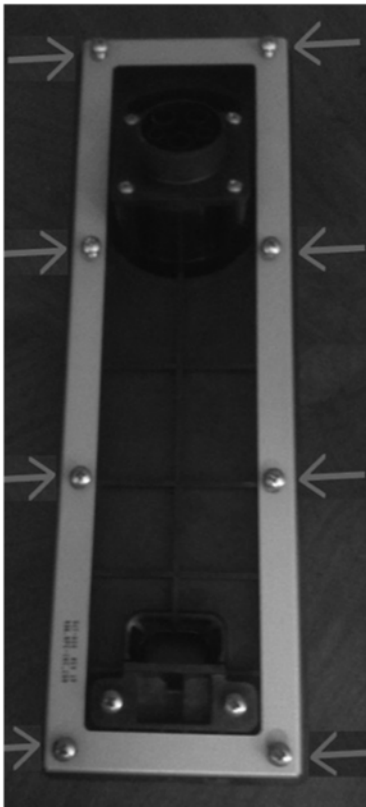

Figure 16 – Front Bezel (Rear View)

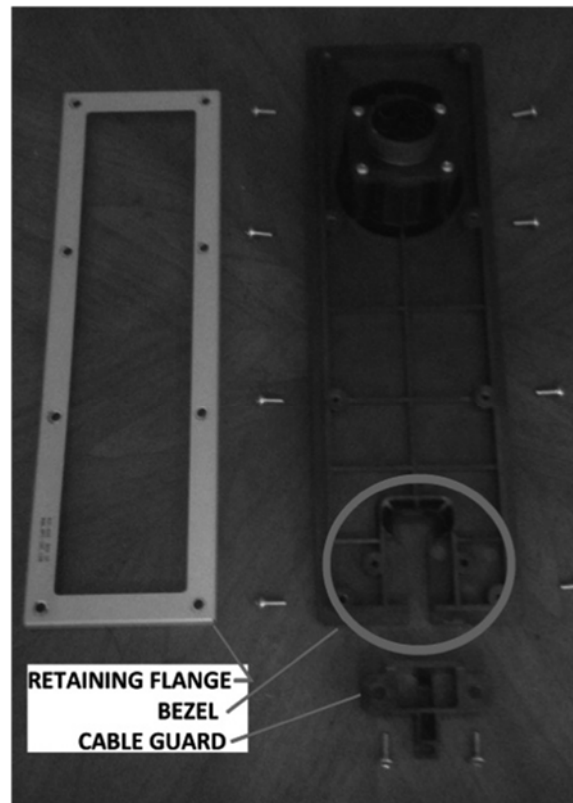

Figure 17 – Front Bezel Disassembled

4. Remove the 2 Phillips-head screws attaching the lower cable guard to the bezel. Retain the screws for later re-installation. Remove the cable guard from the bezel (see Figure 17).
5. Slide the charging cable down out of the cable slot in the bezel. Feed the cable through the large opening in the front housing, and through the bezel retaining flange to free it from the housing.

Cord Reel & Cable Assembly Replacement (continued)

6. Disconnect the cord reel wiring from the terminal block (see Figure 15, page 14).
7. Remove the 2 large Phillips-head screws, washers and lock nuts holding the cord reel in place. Retain the hardware for later re-installation. Carefully remove the cord reel & cable assembly from the L2 PowerPost® EVSE.
8. Carefully install the new cord reel & cable assembly using the 2 Phillips-head screws and lock nuts. Torque lock nuts to 10 in-lbs. Do not over-tighten lock nuts or you may damage the cord reel!
9. Reconnect the cord reel wiring to the terminal block per Figure 15 on page 14.
10. Feed the charging cable through the bezel retaining flange, and through the large opening in the front housing. Slide the charging cable up and into the cable slot in the plastic front bezel.
11. Reinstall the lower cable guard into the bezel. Reinstall the 2 Phillips-head screws attaching the lower cable guard to the bezel. Torque screws to 10 in-lbs. Do not over-tighten screws or you may damage the plastic! (See Figure 17, page 15)
12. Place the plastic bezel onto the front housing. Install the retaining flange behind the bezel and install the 8 Phillips-head screws in the metal retaining flange. Torque screws to 10 in-lbs. Do not over-tighten screws or you may damage the plastic! (See Figure 16)
13. Re-assemble the L2 PowerPost® EVSE per steps 10-14 in the Installation section.

LIMITED WARRANTY AND EXCLUSIONS

Konnectronix warrants to the original purchaser, and not for the benefit of anyone else, that this product is free of defects in materials and workmanship under normal and proper use for the following warranty periods:

- a. For the Cord Reel assembly, 18 months from the purchase date;
- b. For all other components, 36 months from the purchase date.

If a part fails due to defect during the applicable warranty period, Konnectronix will provide at no charge a new or remanufactured part, at Konnectronix's option, and that is Konnectronix's exclusive obligation under this warranty for a product failure. This warranty does not cover labor or other costs incurred to diagnose, repair, remove, install, ship, service or handle defective or replacement parts, or for removal or reinstallation of the product. This warranty is void if this product is installed improperly or in an improper environment, overloaded, misused, abused, or altered in any manner, or is not used and properly maintained under normal operating conditions or not in accordance with any labels or instructions. This warranty does not cover damage caused by electrical spikes, power surge or lightning.

Limited Warranty and Exclusions (continued)

There are no other or implied warranties of any kind, including merchantability and fitness for a particular purpose, but if any implied warranty is required by the applicable jurisdiction, the duration of any such implied warranty, including merchantability and fitness for a particular purpose, is limited to one year. Konnectronix is not liable for incidental, indirect, special, or consequential damages, including without limitation damage to, or loss of use of, any equipment, lost sales or profits, or delay or failure to perform this warranty obligation. The remedies provided herein are the exclusive remedies under this warranty, whether based on contract, tort or otherwise. The warranty is to the original owner only and is not transferable.

COMPLIANCE

SAE J1772

UL Listed: Electric Vehicle Charging Station E359477

NEMA

SPECIFICATIONS

Mechanical

- / Dimensions: 35.5" High x 6" Wide x 9" Deep (16½" with stowed Charge Coupler)
- / Weight: 24 lbs
- / Charging Cable Length: 14' Retractable
- / Operating Temperature: -30°C to +50°C (-22°F to +122°F)
- / Waterproof Rating: UL 50E Type 3R Rating

Electrical

- / Input Power: 208-240 VAC – Single Phase – 50/60Hz – 14A Max Current Draw
- / Output Power: 220VAC – 60 Hz – 14A Max
- / Standby Power Consumption: 9W (40 mA @220V)
- / Surge Suppression: 10000A / 620V Max
- / Ground Fault Sensitivity: 20mA min

OTHER

PATENTS

The Electrical Cord Reel Assembly (ECR) used in the L2 PowerPost® Electrical Vehicle Service Equipment is covered by US 8,387,763 B2 as well as additional patents pending. Aspects of the L2 PowerPost® Electrical Vehicle Service Equipment are the subject of patents pending.

SOFTWARE

An executable copy of the CONSOLE_2342 program is provided with the L2 PowerPost® EVSE hardware system.

SOFTWARE (continued)

The CONSOLE_2342 program is modified by Konnectronix as of 2013 using Open EVSE, and is released as licensed under the GPLv3 License. CONSOLE_2342 is free software: you can redistribute it and/or modify it under the terms of the GNU General Public License as published by the Free Software Foundation, under version 3 of the License (which may be viewed at: <http://www.gnu.org/licenses/gpl.html>).

This program is distributed in the hope that it will be useful, but WITHOUT ANY WARRANTY; without even the implied warranty of MERCHANTABILITY or FITNESS FOR A PARTICULAR PURPOSE. See the GNU General Public License for more details. No licenses for any patents, trademarks or trade secrets related to the L1 Power Post or any other hardware or systems, however, is granted hereunder.

Konnectronix will, upon request, make available a schematic pursuant to the Creative Commons Public License version 3.0 (the "CCPL," available at <http://creativecommons.org/licenses/by-sa/3.0/legalcode>). Such schematics detail enhancements provided by Konnectronix, and such Konnectronix schematics use (among other sources) EVSE power supply schematics provided by Open EVSE and available at <https://code.google.com/p/open-evse/>. No connection with, sponsorship, warranties or endorsement by Open EVSE or its members of such schematics, of Konnectronix or its use any works is asserted or implied hereunder. Any Konnectronix copyrights related to such schematics may be used pursuant to the rights and obligations of the CCPL, which may be viewed at the link provided above. Nothing under this agreement, however, shall provide rights to any Konnectronix trademarks, patents or trade secrets, all such rights being reserved.

CONTACT INFORMATION

Contact Konnectronix, Inc. for customer service, technical support and warranty claims. For information about the [Konnectronix L1 PowerPost® EVSE visit: www.PowerPostEVSE.com](#).



2340 Ernie Krueger Circle
Waukegan, IL 60087
Phone: 847.672.8685
Fax: 847.672.8419
www.konnectronix.com
www.powerpostevse.com

**Designed, Engineered, and
Manufactured in the U.S.A.**

Copyright © 2018 Konnectronix, Inc. All Rights Reserved. Konnectronix™ is a trademark of Konnectronix, Inc. L1 PowerPost® EVSE is a trademark of Konnectronix, Inc.